

---

# ATLANTA

## STRETCH

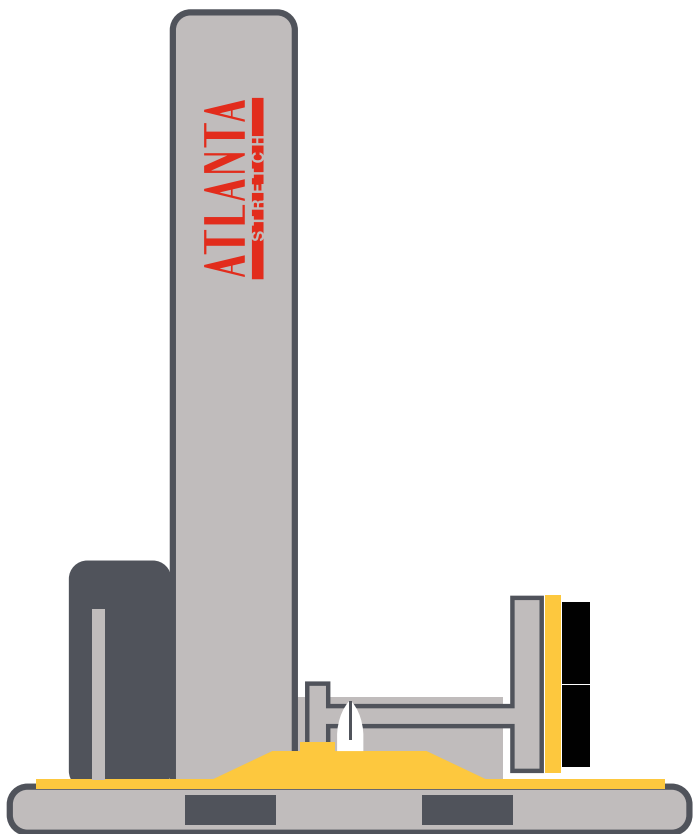

**MYTHO AUTO**

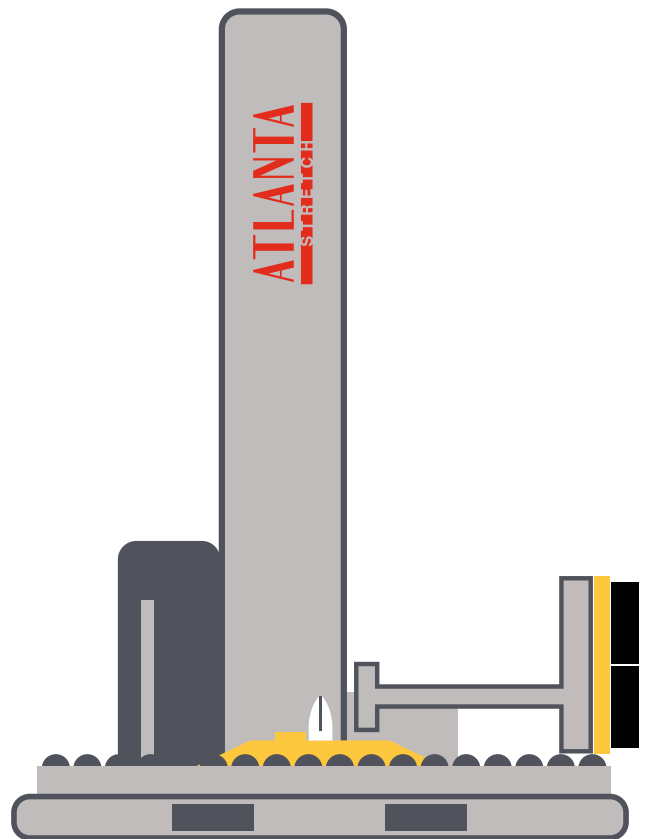

**MYTHO STATION**

PALLET WRAPPING MACHINE  
MAINTENANCE FREE  
EASY INSTALLATION

**Turntable for wrapping pallets  
with stretch film without operator**

## MYTHO AUTO

Input: 230 Volt  
1 PHASE



## MYTHO AUTO TP

Input: 230 Volt  
1 PHASE

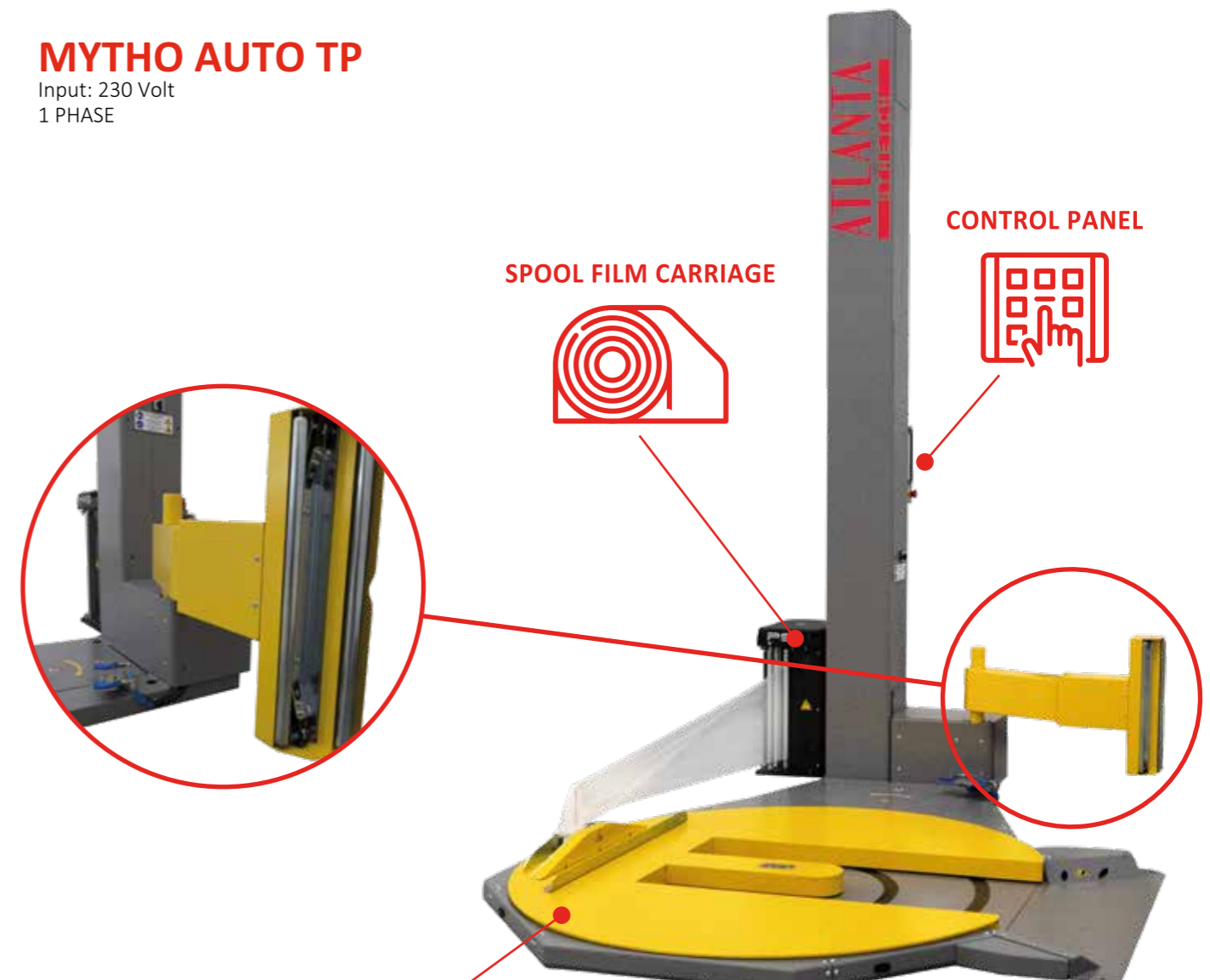

### ATLANTA STRETCH UNIQUE SOLUTION

- IT** Protezioni di sicurezza non necessarie per CE – IIA totale
- EN** Safety Fences not necessary for Full CE - IIA
- FR** Les clôtures de sécurité ne sont pas nécessaires pour le plein CE – IIA
- DE** Sicherheitszäune nicht erforderlich für volles CE - IIA
- ES** Las vallas de seguridad no son necesarias para CE - IIA completo

### CLAMP AND CUTTING SYSTEM

- IT** Sistema saldatura del film estensibile autoregolante per qualsiasi dimensione del pallet.
- EN** Film weld unit self adjusting for any size of pallet.
- FR** Système de soudure du film étirable à réglage automatique pour toutes dimensions de la palette.
- DE** Selbsteinstellendes Folienende Verschweißsystem passt sich auf sämtliche Palettengrößen automatisch an.
- ES** Sistema soldadura del film extensible autorregulable para cualquier dimensión de palet.

TURNTABLE



TURNTABLE



### PALLET DIMENSIONS

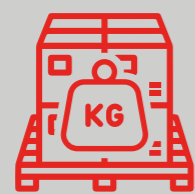
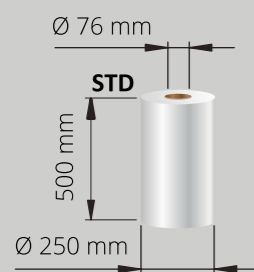

Max: 2000 Kg STD

#### Mytho Mast

- H = 2200 STD
- H = 2400 OPT
- H = 2500 OPT
- H = 3000 OPT
- H = 3200 OPT
- H = 3500 OPT
- H = 3900 OPT

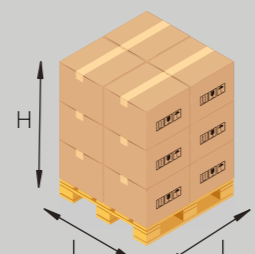

- L=800x1200 mm Ø 1500 max STD
- L=1000x1200 mm Ø 1650 max OPT
- L=1200x1200 mm Ø 1800 max OPT
- L=1500x1500 mm Ø 2200 max OPT
- L=1650x1650 mm Ø 2400 max OPT
- L=1830x1830 mm Ø 2600 max OPT

### APPLICATIONS

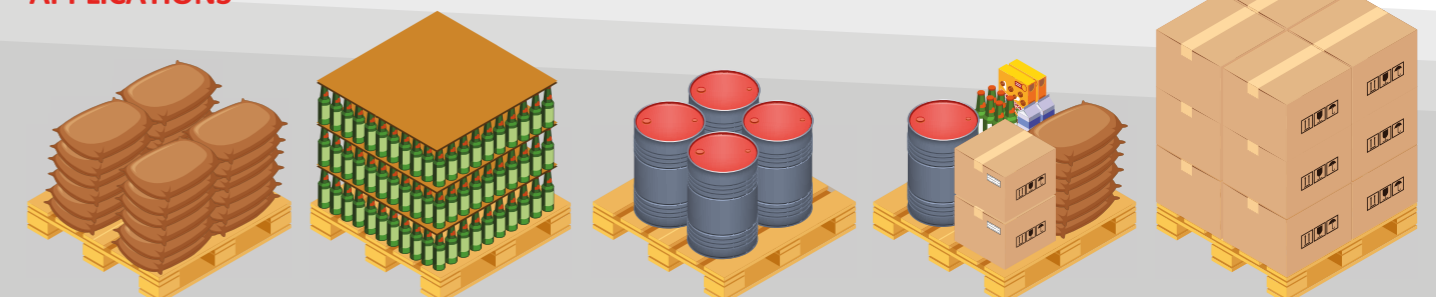



## ATLANTA STRETCH SELLING POINTS

### EXCHANGEABLE CARRIAGES



- IT** Carrelli porta bobina intercambiabili anche dopo la consegna della macchina con un notevole risparmio.
- EN** The carriage can be upgraded even after delivery, to achieve lower costs of ownership.
- FR** Le chariot peut être mis à niveau même après la livraison, afin de réduire les coûts de possession.
- DE** Austauschbarer Folienschlitten auch nach Auslieferung der Maschine, zur Reduzierung der Betriebskosten
- ES** El carro se puede actualizar incluso después de la entrega, para lograr menores costos de propiedad.

### ERGONOMIC SOLUTION FOR THE USER



- IT** L'attenzione alla sicurezza e al massimo comfort del lavoratore contribuiscono a migliorare la qualità del lavoro, diminuendo lo stress a favore della soddisfazione generale dell'utente
- EN** For the highest security and safety of the user and to achieve a better working environment, and higher satisfaction of the user.
- FR** Pour la plus grande sécurité et sûreté de l'utilisateur et pour obtenir un meilleur environnement de travail et une plus grande satisfaction de l'utilisateur.
- DE** Für höchste Sicherheit des Nutzers, sowie zur Erreichung eines besseren Arbeitsumfelds und Zufriedenheit
- ES** Para la mayor seguridad y protección del usuario y para lograr un mejor ambiente de trabajo, y una mayor satisfacción del usuario.

### COMMERCIAL COMPONENTS AND INVERTERS AVAILABLE ON THE FREE MARKET



- IT** La facilità con cui i nostri componenti sono reperibili sul mercato contribuisce ad abbatterne il prezzo con notevole risparmio per l'utente.
- EN** The use of commercial components in all our products means higher reliability and lower costs but also flexibility in terms of materials supply.
- FR** La façon dont nous nous approvisionnons et spécifions des niveaux élevés pour les composants de nos produits, signifie que vous bénéficierez de niveaux de fiabilité élevés et constants
- DE** Der Einsatz handelsüblicher Komponenten in all unseren Produkten bedeutet höhere Zuverlässigkeit und geringere Kosten, aber auch Flexibilität bei der Materialversorgung.
- ES** El uso de componentes comerciales en todos nuestros productos significa mayor confiabilidad y menores costos, pero también flexibilidad en términos de suministro de materiales.

### POSSIBILITY TO ADJUST TENSION ON LOAD AND PRE STRETCH IN EVERY STEP OF THE WRAPPING CYCLE



- IT** I nostri carrelli offrono la possibilità di regolare in maniera mirata la tensione del film e il pre-stretch in ogni fase dell'avvolgimento.
- EN** Our carriages are standard equipped with the possibility to adjust film tension and pre-stretch during every phase of the wrapping process.
- FR** Nos chariots sont tous équipés en mode standard avec la possibilité de régler la tension du film et de le pré-étirer à chaque étape du processus d'emballage.
- DE** Unsere Folienschlitten sind so konzipiert, dass sowohl die Anlegespannung als auch die Folienvordehnung in jeder Phase des Wickelzyklus regulierbar sind.
- ES** Nuestros carros están equipados de serie con la posibilidad de ajustar la tensión de la película y preestirar durante cada fase del proceso de envoltura.



## OPERATING PANEL

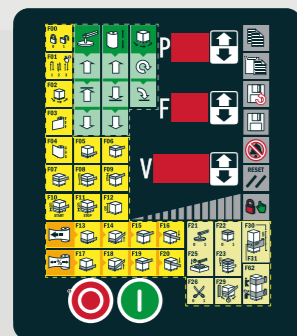

**DISPLAY** 11" easy to use touch screen

**Mytho Auto:** 99 PROGRAMS

- IT** Pannello di controllo multifunzionale programmabile
- EN** Multifunction programmable control panel
- FR** Panneau de controle multifonction programmable
- DE** Multifunktion programmierbare Systemsteuerung
- ES** Panel de control programable multifuncion

## MYTHO STATION

Input: 230 Volt  
1 PHASE



SPOOL FILM CARRIAGE

CONTROL PANEL



TURNTABLE

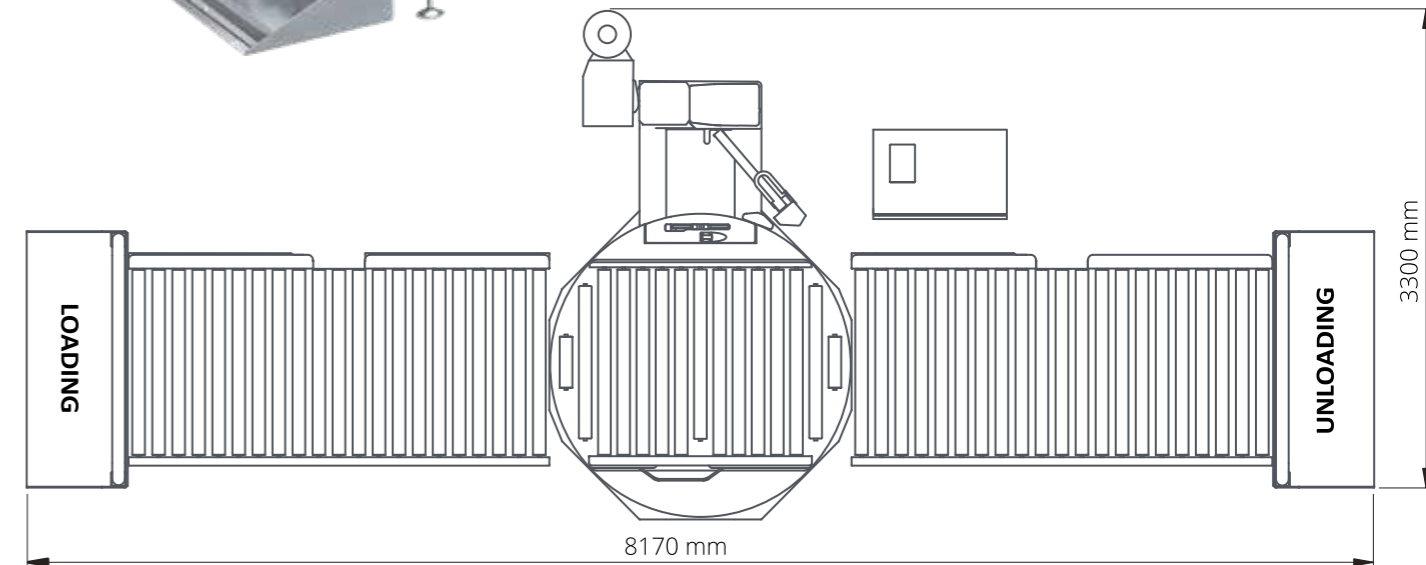
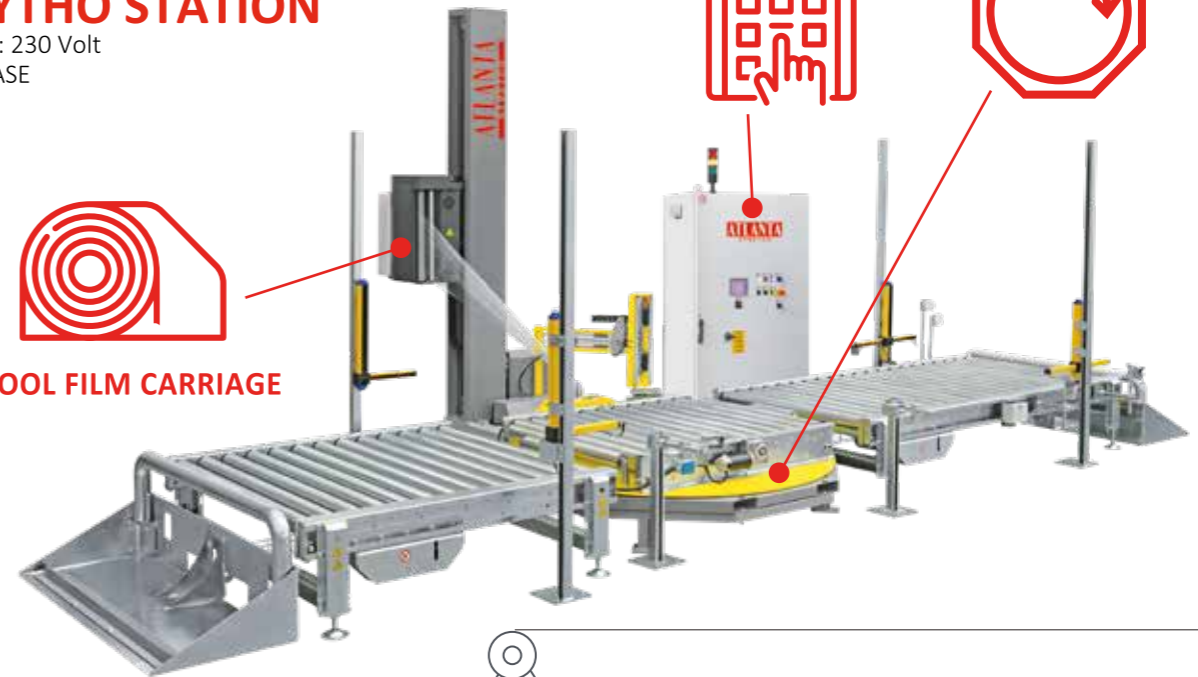
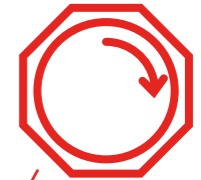

### WRAPPING PROGRAMS

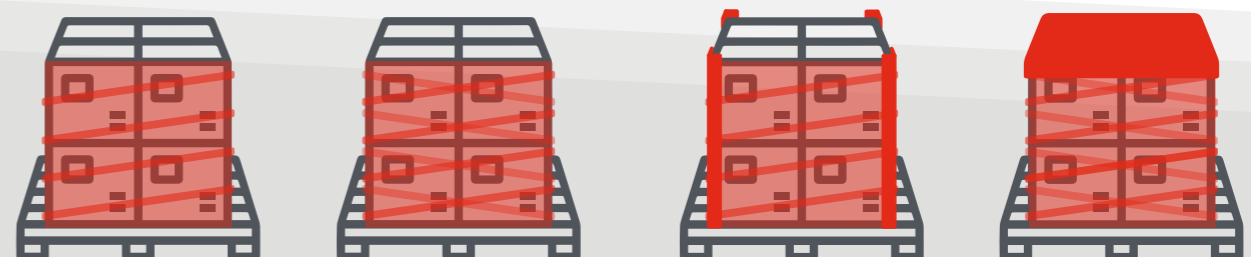

## SPOOL FILM CARRIAGE



### EASY FILM CHANGE

- IT** Cambio film semplificato, altezza di arresto del carrello porta bobina automatico.
- EN** Easy reel change, adjustable service height.
- FR** Changement de bobine facile, hauteur de service réglable.
- DE** Einfacher Folienwechsel in ergonomischer Arbeitshöhe.
- ES** Cambio fácil de bobina, altura de embalaje ajustable.

### FE

- IT** Frizione elettromagnetica regolabile da pannello comandi.
- EN** Electromagnetic friction adjustable from control panel.
- FR** Frein électromagnétique réglable depuis le panneau de commande.
- DE** Elektromagnetische Bremse auf Umlenkwalze vom Bedienpult instellbar.
- ES** Fricción electromagnética regulable desde el panel de comandos.

### PRS POWER ROLLER STRETCH

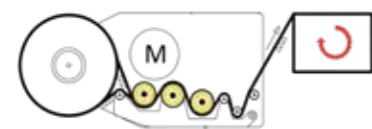

- IT** Sistema di prestiro motorizzato a 3 rulli comandato elettronicamente con rapporti intercambiabili: 150- 200- 250%.
- EN** Motorized pre-stretch system with 3 driven rollers electronically controlled with interchangeable ratios: 150- 200- 250%.
- FR** Système de pré-étirage motorisé et asservi à 3 rouleaux, rapports interchangeables: 150- 200- 250%.
- DE** Angetriebener Vordehnssystem mit 3 Vordehnrollen, elektronisch gesteuert mit leicht wechselbarer Zahnradsätzen: 150- 200- 250%.
- ES** Sistema de prestiro motorizado con 3 rodillos, comandado electrónicamente con desarrollos intercambiables: 150- 200- 250%.

### PS POWER STRETCH

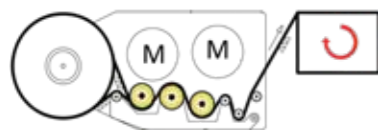

- IT** Sistema di motorizzato a 3 rulli con 2 motori e variazione da 120 a 350% regolabile da quadro comandi.
- EN** Motorized pre-stretch system with 3 driven rollers and 2 motors adjustable between 120 to 350% from control panel.
- FR** Système de pré-étirage motorisé et asservi à 3 rouleaux et 2 moteurs, rapport ajustable de 120 à 350% depuis le panneau de commande.
- DE** Angetriebener Vordehnssystem mit 3 Vordehnrollen und 2 Motoren, stufenlos regelbare Werte zwischen 120 und 350% von Bedienpult.
- ES** Sistema de prestiro motorizado con 3 rodillos y 2 motores, regulable da 120 a 350% desde el panel de comandos.

## MEANS OF LOADING MYTHO AUTO

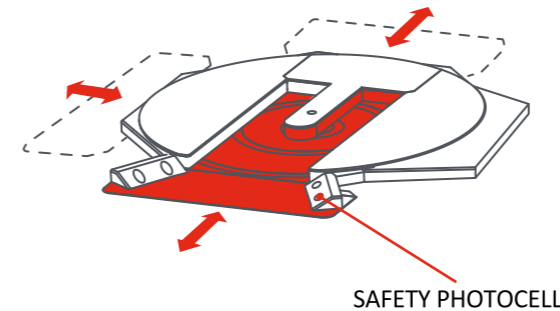
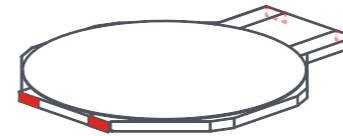

## OPTIONALS

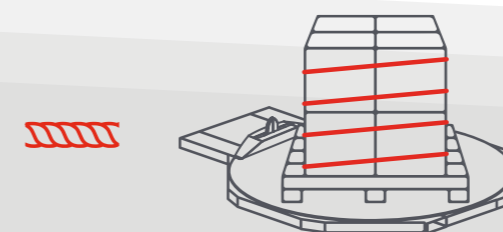
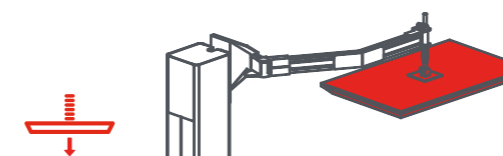
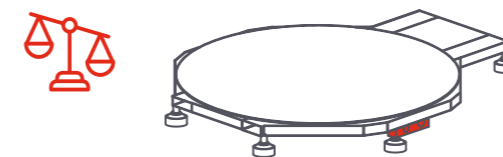

### FORK SLOTS ON BOTH SIDES FOR EASY TRANSPORT



- IT** Trasporto facile
- EN** Easy transport
- FR** Transport facile
- DE** Einfachen transport
- ES** Facil transporte

### TP BASEMENT



- IT** Versione transpallet con 3 possibili vie di carico. Direzione di ingresso tp modificabile anche dopo consegna.
- EN** Transpallet version with 3 in-feeds. Infeed direction changeable lifetime.
- FR** Ausführung Transpallet mit 3 adenmöglichkeiten.
- DE** Version transpalette 3 voies.
- ES** Version transpallet 3 posiciones de carga.

**Pallet dimension**  
 Ø 1650 Max 1000x1200 mm  
 Ø 1800 Max 1200x1200 mm  
 Max weight 1200 kg

### INTEGRATED WEIGHTING SYSTEM (ALSO FOR TP TURNTABLE)

- IT** Sistema elettronico per l'indicazione del peso del estensibile utilizzato.
- EN** Integrated calculation system, to indicate the weight of the used stretchfilm.
- FR** Système de calcul intégré pour indiquer le poids de film utilisé.
- DE** Integriertes Berechnungssystem, um das Gewicht des verwendeten Stretchfilms anzuzeigen.
- ES** Sistema integrado de cálculo, que indica el peso del plástico de preestiro utilizado.

### TOP PRESSURE UNIT

- IT** Pressore tenuta pallet
- EN** Pallet holder presser
- FR** Plateu stabilisateur de charge
- DE** Palettendruchalter
- ES** Prensor retencion palet

### ROPING SYSTEM

- IT** Sistema di cordonatura film: Permette di ridurre l'altezza del film formando un cordone che assicura una più efficiente stabilizzazione del carico.
- EN** Roping System: Reducing the film width to form a rope to ensure more effective load stabilisation.
- FR** Systeme permettant de réduire la laize du film en formant un cordon qui assure une meilleure stabilisation de la charge.
- DE** Schnurrvorrichtung: Reduzierung der Folienbreite zur Schnur um eine bessere Stabilisierung der Ladung zu gewährleisten.
- ES** Sistema de Cordón. Permite reducir la altura del film formando un cordón que asegura con mas eficacia la estabilidad de la carga.

# SEMI AUTOMATIC RANGE

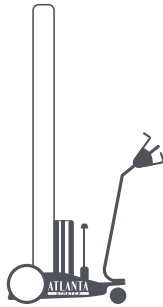

MARATHON

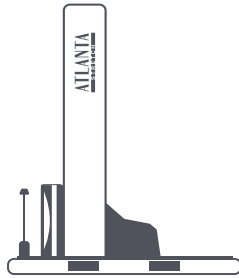

EVA

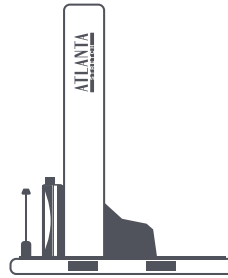

SYNTHESI

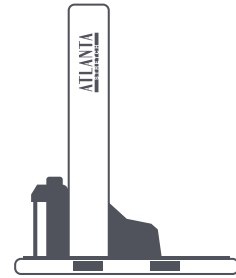

SYNTHEX

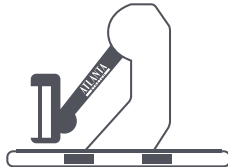

MYTHO ARM

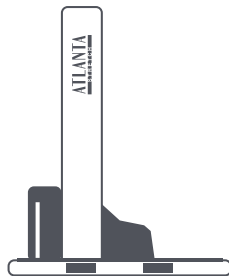

MYTHO MAST



SFERA

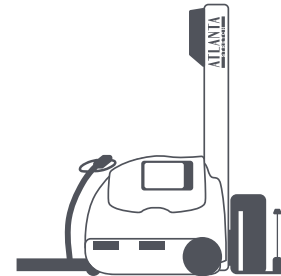

SFERA MAST

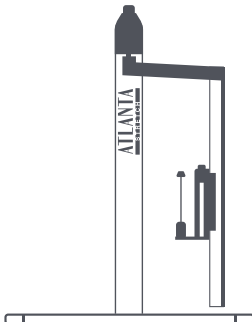

LYBRA EASY

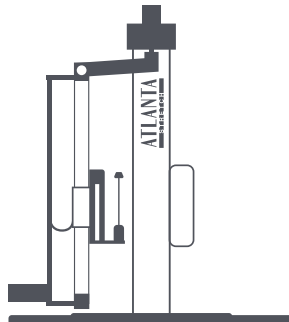

LYBRA

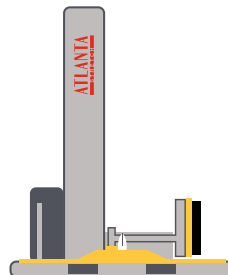

MYTHO AUTO

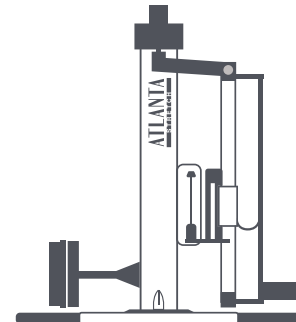

LYBRA AUTO

Atlanta Stretch Authorized dealer

**ATLANTA**  
**STRETCH**

stretch wrapping machines specialist

Headquarter: Atlanta Stretch Italy Spa

Subsidiaries: Atlanta Stretch Australia - Atlanta Stretch China - Atlanta Stretch Deutschland - Atlanta Stretch France - Atlanta Stretch Iberica - Atlanta Stretch India - Atlanta Stretch Mexico - Atlanta Stretch Russia - Atlanta Stretch SEA - Atlanta Stretch Turkey - Atlanta Stretch UK



View all  
optional tools  
here

[www.atlantastretch.com](http://www.atlantastretch.com)

Find  
all our  
dealers

